

* 所有原料材质, 生产制程, 电镀必须符合IHF要求

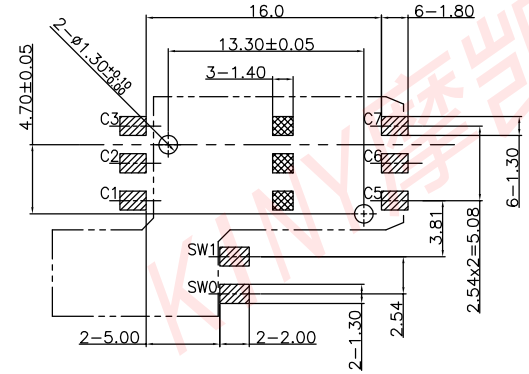

BOARD PAD NO WIRING AREA
Recommended PCB Layout
General Tolerance : ±0.10mm

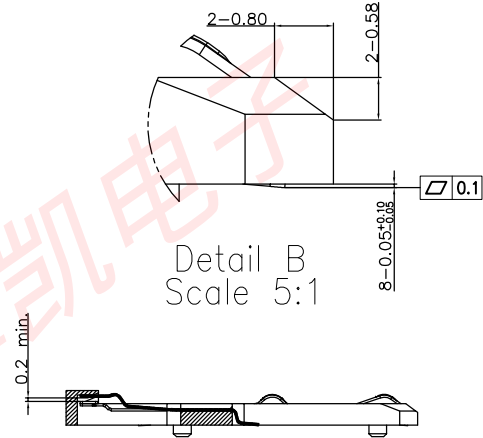
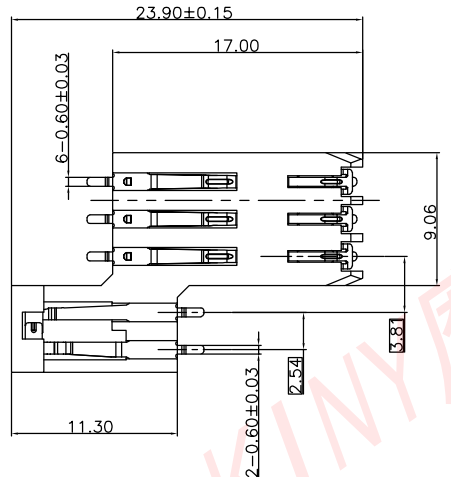
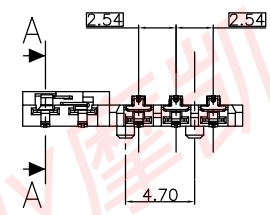
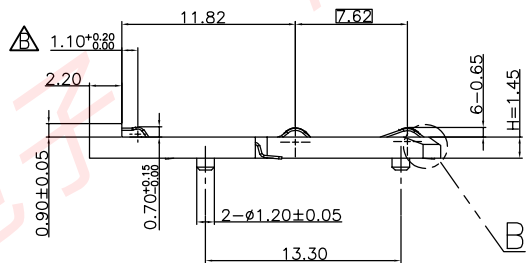

- NOTE :
- Material:
 - 1-1 Housing: High Temperature Thermoplastic, LCP, Color: Black, UL94V-0
 - 1-2 Terminal and Switch: Phosphor Bronze, T=0.15mm
 - Plating:
 - Contact Area: Gold 1μ"
 - Solder Area: Gold Flash.
 - Underplating: Ni overall 80μ" min.
 - Specification:
 - 3-1 Contact Current Rating: 0.5A
 - 3-2 Dielectric Withstanding Voltage: AC500V r.m.s.
 - 3-3 Insulation Resistance: 1000 MΩ Minimum, at DC 500V.
 - 3-4 Contact Resistance: 100 mΩ Maximum.
 - 3-5 Mating Cycle: 100,000 Insertions.

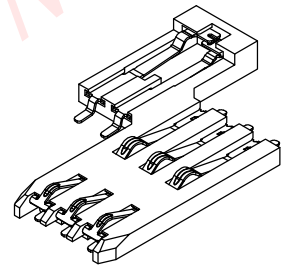
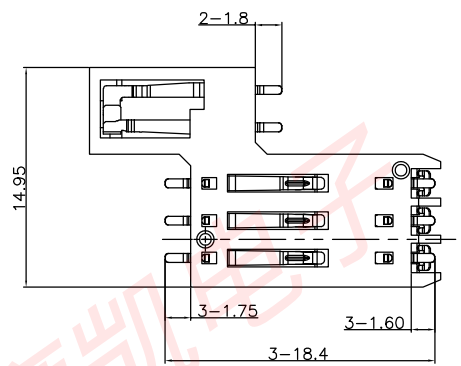
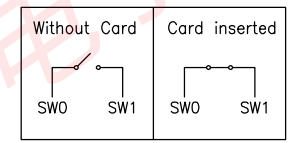

| | | | | |
|--------------|----------------|-------------------------|-------|------------|
| B | ECN20200313001 | 为改善插卡不到位, 开关PIN接触点后移0.5 | Faji | 2020.03.13 |
| A | ---- | NEW RELEASE | janyz | 2019.07.12 |
| REVISION NO. | ECR NO. | DESCRIPTION | MARK | DATE |

| | | | | | |
|---|--|-----------------------------------|-------------------|---------------------|-----------------|
| | | 东莞市摩凯电子有限公司 | | | |
| | | PRODUCT NAME : SIM-D H1.45 卡座 | DRAWING: Faji | DATE: 2020.03.13 | |
| DIMENSIONS INIT: mm UNLESS OTHERWISE SPECIFIABLE DIMENSION TOLERANCE X.X: ± 0.35 X.XX: ± 0.20 X.XXX: ± 0.10 ANGULAR: ± 2' | | PRODUCT NO. : SM145-T1200-01 | CHECK: Alex | DATE: 2020.03.13 | |
| | | DRAWING NO. : D-SM145-T1200-01 | APPROVED: Alex | DATE: 2020.03.13 | |
| | | SCALE: 1:1 | DWG ID: C D | REV.: B | PAGE: 1 OF 1 |