

* 所有原料材质, 生产制程, 电镀必须符合H要求

NOTES:

SPECIFICATION:

1. CURRENT RATING: 3.0A MAX
2. DIELECTRIC WITHSTANDING VOLTAGE: 100 VAC
3. TEMPERATURE RANGE: -30 °C ~ 85 °C
4. CONTACT RESISTANCE: 40 MILLIONHM MAX
5. INSULATION RESISTANCE: 100 MEGOHMS MIN.
6. INSERTION FORCE : 5N~20N
7. UNMATING FORCE: 8N~20N
8. DURABILITY: 10000 CYCLES

A5	CC1	B12	GND
A9	VBUS	B9	VBUS
A12	GND	B5	CC2
PIN	SIGNAL NAME	PIN	SIGNAL NAME

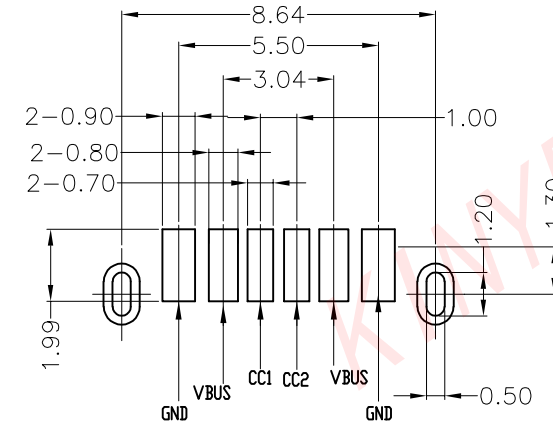
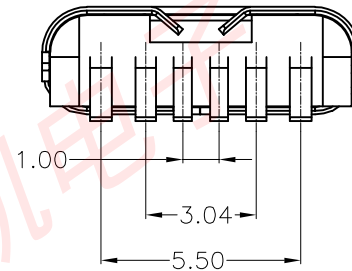
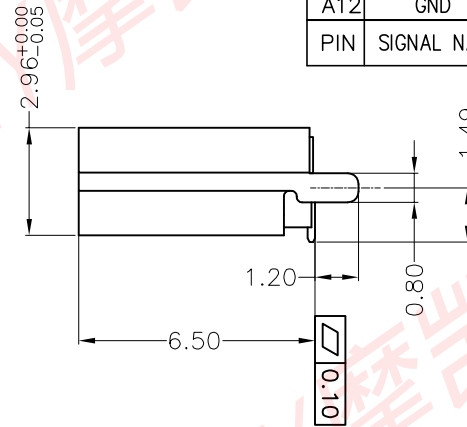
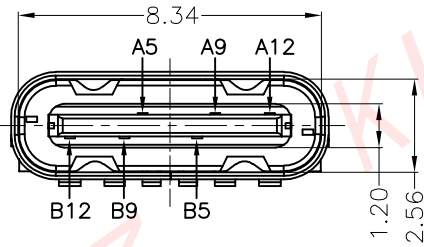
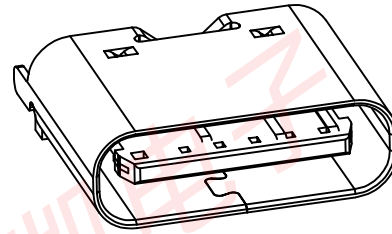
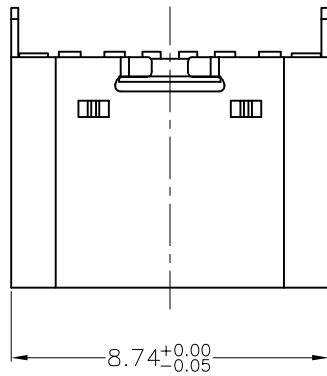

RECOMMENDED P.C.B. LAYOUT
TOLERANCE UNSPECIFIED ±0.05mm

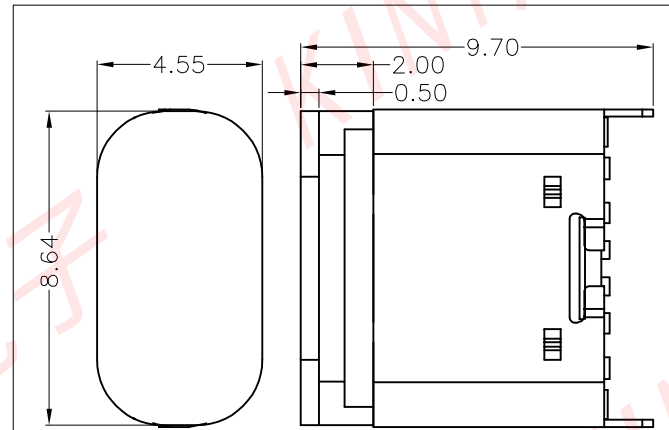
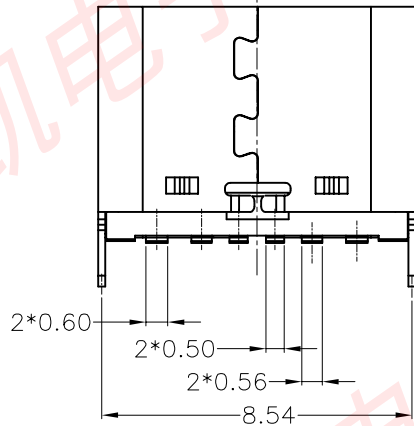

加塞子示意图

5	COVER	HIGH TEMPERATURE PLASTIC	BLACK	1PCS
4	SHIELDING PLATE	STAINLESS STEEL	NO Plated	1PCS
3	SHELL	STAINLESS STEEL	Ni:50u" Plated	1PCS
2	CONTACT	COPPER ALLOY	Au1u"/Ni:50u" Plated	1SET
1	HOUSING	HIGH TEMPERATURE PLASTIC	BLACK	1PCS
NO.	DESCRIPTION	MATERIAL	REMARKS	QTY

KINY

东莞市摩凯电子有限公司

DIMENSIONS INIT: mm
UNLESS OTHERWISE SPECIFIABLE
DIMENSION TOLERANCE
X.X: ± 0.35
X.XX: ± 0.20
X.XXX: ± 0.10
ANGULAR: ± 2'

PRODUCT NAME :	USB C F 6P直立式 SMT成品	DRAWING:	FAJI	DATE:	2019.05.30
PRODUCT NO. :	TPC06-F1250-01	CHECK:	Alex	DATE:	2019.05.30
DRAWING NO. :	D-TPC06-F1250-01	APPROVED:	Alex	DATE:	2019.05.30
SCALE:	1:1	DWG ID:	C D	REV.:	A
				PAGE:	1 OF 1

A	---	NEW RELEASE	FAJI	2019.05.30
REVISION NO.	ECR NO.	DESCRIPTION	MARK	DATE
1				